



OPERATOR'S MANUAL

Metal Working



METAL BEAD ROLLER MODEL: BR-18E-24 AND BR-18E-36

Baileigh Industrial Holdings LLC
P.O. Box 531
Manitowoc, WI 54221-0531
Phone: 920.684.4990
Fax: 920.684.3944
sales@baileigh.com

REPRODUCTION OF THIS MANUAL IN ANY FORM WITHOUT WRITTEN APPROVAL OF BAILEIGH INDUSTRIAL HOLDINGS LLC IS PROHIBITED. Baileigh Industrial Holdings LLC, Inc. does not assume and hereby disclaims any liability for any damage or loss caused by an omission or error in this Operator's Manual, resulting from accident, negligence, or other occurrence.



Table of Contents

THANK YOU & WARRANTY	1
INTRODUCTION.....	3
GENERAL NOTES.....	3
SAFETY INSTRUCTIONS	4
SAFETY PRECAUTIONS	6
Dear Valued Customer:.....	6
TECHNICAL SPECIFICATIONS	8
TECHNICAL SUPPORT	8
UNPACKING AND CHECKING CONTENTS.....	9
INSTALLATION.....	10
Anchoring the Machine.....	10
ASSEMBLY.....	11
ELECTRICAL.....	13
GENERAL BEAD ROLLING	15
ROLLER INSTALLATION AND REMOVAL	15
OPERATION.....	17
MATERIAL SELECTION.....	18
UNDERSTANDING SPRINGBACK	19
LUBRICATION AND MAINTENANCE	19
PARTS DIAGRAM A.....	20
PARTS DIAGRAM B.....	21
Parts Identification List	22
ELECTRICAL SCHEMATIC.....	24
Electrical Components.....	25



THANK YOU & WARRANTY

Thank you for your purchase of a machine from Baileigh Industrial Holdings LLC. We hope that you find it productive and useful to you for a long time to come.

Inspection & Acceptance. Buyer shall inspect all Goods within ten (10) days after receipt thereof. Buyer's payment shall constitute final acceptance of the Goods and shall act as a waiver of the Buyer's rights to inspect or reject the goods unless otherwise agreed. If Buyer rejects any merchandise, Buyer must first obtain a Returned Goods Authorization ("RGA") number before returning any goods to Seller. Goods returned without an RGA will be refused. Seller will not be responsible for any freight costs, damages to goods, or any other costs or liabilities pertaining to goods returned without a RGA. Seller shall have the right to substitute a conforming tender. Buyer will be responsible for all freight costs to and from Buyer and repackaging costs, if any, if Buyer refuses to accept shipment. If Goods are returned in unsalable condition, Buyer shall be responsible for full value of the Goods. Buyer may not return any special-order Goods. Any Goods returned hereunder shall be subject to a restocking fee equal to 30% of the invoice price.

Specifications. Seller may, at its option, make changes in the designs, specifications or components of the Goods to improve the safety of such Goods, or if in Seller's judgment, such changes will be beneficial to their operation or use. Buyer may not make any changes in the specifications for the Goods unless Seller approves of such changes in writing, in which event Seller may impose additional charges to implement such changes.

Limited Warranty. Seller warrants to the original end-user that the Goods manufactured or provided by Seller under this Agreement shall be free of defects in material or workmanship for a period of twelve (12) months from the date of purchase, provided that the Goods are installed, used, and maintained in accordance with any instruction manual or technical guidelines provided by the Seller or supplied with the Goods, if applicable. The original end-user must give written notice to Seller of any suspected defect in the Goods prior to the expiration of the warranty period. The original end-user must also obtain a RGA from Seller prior to returning any Goods to Seller for warranty service under this paragraph. Seller will not accept any responsibility for Goods returned without a RGA. The original end-user shall be responsible for all costs and expenses associated with returning the Goods to Seller for warranty service. In the event of a defect, Seller, at its sole option, shall repair or replace the defective Goods or refund to the original end-user the purchase price for such defective Goods. Goods are not eligible for replacement or return after a period of 10 days from date of receipt. The foregoing warranty is Seller's sole obligation, and the original end-user's exclusive remedy, with regard to any defective Goods. This limited warranty does not apply to: (a) die sets, tooling, and saw blades; (b) periodic or routine maintenance and setup, (c) repair or replacement of the Goods due to normal wear and tear, (d) defects or damage to the Goods resulting from misuse, abuse, neglect, or accidents, (e) defects or damage to the Goods resulting from improper or unauthorized alterations, modifications, or changes; and (f) any Goods that has not been installed and/or maintained in accordance with the instruction manual or technical guidelines provided by Seller.

EXCLUSION OF OTHER WARRANTIES. THE FOREGOING LIMITED WARRANTY IS IN LIEU OF ALL OTHER WARRANTIES, EXPRESS OR IMPLIED. ANY AND ALL OTHER EXPRESS, STATUTORY OR IMPLIED WARRANTIES, INCLUDING BUT NOT LIMITED TO, ANY WARRANTY OF MERCHANTABILITY OR FITNESS FOR ANY PARTICULAR PURPOSE ARE EXPRESSLY DISCLAIMED. NO WARRANTY IS MADE WHICH EXTENDS BEYOND THAT WHICH IS EXPRESSLY CONTAINED HEREIN.

Limitation of Liability. IN NO EVENT SHALL SELLER BE LIABLE TO BUYER OR ANY OTHER PARTY FOR ANY INCIDENTAL, CONSEQUENTIAL OR SPECIAL DAMAGES (INCLUDING, WITHOUT LIMITATION, LOST PROFITS OR DOWN TIME) ARISING FROM OR IN MANNER CONNECTED WITH THE GOODS, ANY BREACH BY SELLER OR ITS AGENTS OF THIS AGREEMENT, OR ANY OTHER CAUSE WHATSOEVER, WHETHER BASED ON CONTRACT, TORT OR ANY OTHER THEORY OF LIABILITY. BUYER'S REMEDY WITH RESPECT TO ANY CLAIM ARISING UNDER THIS AGREEMENT IS STRICTLY LIMITED TO NO MORE THAN THE AMOUNT PAID BY THE BUYER FOR THE GOODS.



Force Majeure. Seller shall not be responsible for any delay in the delivery of, or failure to deliver, Goods due to causes beyond Seller's reasonable control including, without limitation, acts of God, acts of war or terrorism, enemy actions, hostilities, strikes, labor difficulties, embargoes, non-delivery or late delivery of materials, parts and equipment or transportation delays not caused by the fault of Seller, delays caused by civil authorities, governmental regulations or orders, fire, lightening, natural disasters or any other cause beyond Seller's reasonable control. In the event of any such delay, performance will be postponed by such length of time as may be reasonably necessary to compensate for the delay.

Installation. If Buyer purchases any Goods that require installation, Buyer shall, at its expense, make all arrangements and connections necessary to install and operate the Goods. Buyer shall install the Goods in accordance with any Seller instructions and shall indemnify Seller against any and all damages, demands, suits, causes of action, claims and expenses (including actual attorneys' fees and costs) arising directly or indirectly out of Buyer's failure to properly install the Goods.

Work By Others; Safety Devices. Unless agreed to in writing by Seller, Seller has no responsibility for labor or work performed by Buyer or others, of any nature, relating to design, manufacture, fabrication, use, installation or provision of Goods. Buyer is solely responsible for furnishing and requiring its employees and customers to use all safety devices, guards and safe operating procedures required by law and/or as set forth in manuals and instruction sheets furnished by Seller. Buyer is responsible for consulting all operator manuals, ANSI or comparable safety standards, OSHA regulations and other sources of safety standards and regulations applicable to the use and operation of the Goods.

Remedies. Each of the rights and remedies of Seller under this Agreement is cumulative and in addition to any other or further remedies provided under this Agreement or at law or equity.

Attorney's Fees. In the event legal action is necessary to recover monies due from Buyer or to enforce any provision of this Agreement, Buyer shall be liable to Seller for all costs and expenses associated therewith, including Seller's actual attorney fees and costs.

Governing Law/Venue. This Agreement shall be construed and governed under the laws of the State of Wisconsin, without application of conflict of law principles. Each party agrees that all actions or proceedings arising out of or in connection with this Agreement shall be commenced, tried, and litigated only in the state courts sitting in Manitowoc County, Wisconsin or the U.S. Federal Court for the Eastern District of Wisconsin. Each party waives any right it may have to assert the doctrine of "forum non conveniens" or to object to venue to the extent that any proceeding is brought in accordance with this section. Each party consents to and waives any objection to the exercise of personal jurisdiction over it by courts described in this section. Each party waives to the fullest extent permitted by applicable law the right to a trial by jury.

Summary of Return Policy.

- 10 Day acceptance period from date of delivery. Damage claims and order discrepancies will not be accepted after this time.
- You must obtain a Baileigh issued RGA number PRIOR to returning any materials.
- Returned materials must be received at Baileigh in new condition and in original packaging.
- Altered items are not eligible for return.
- Buyer is responsible for all shipping charges.
- A 30% re-stocking fee applies to all returns.

Baileigh Industrial Holdings LLC makes every effort to ensure that our posted specifications, images, pricing and product availability are as correct and timely as possible. We apologize for any discrepancies that may occur. Baileigh Industrial Holdings LLC reserves the right to make any and all changes deemed necessary in the course of business including but not limited to pricing, product specifications, quantities, and product availability.

For Customer Service & Technical Support:

Please contact one of our knowledgeable Sales and Service team members at:
(920) 684-4990 or e-mail us at sales@baileigh.com



INTRODUCTION

The quality and reliability of the components assembled on a Baileigh Industrial Holdings LLC machine guarantee near perfect functioning, free from problems, even under the most demanding working conditions. However, if a situation arises, refer to the manual first. If a solution cannot be found, contact the distributor where you purchased our product. Make sure you have the serial number and production year of the machine (stamped on the nameplate). For replacement parts refer to the assembly numbers on the parts list drawings.

Our technical staff will do their best to help you get your machine back in working order.

In this manual you will find: (when applicable)

- Safety procedures
- Correct installation guidelines
- Description of the functional parts of the machine
- Capacity charts
- Setup and start-up instructions
- Machine operation
- Scheduled maintenance
- Parts lists

GENERAL NOTES

After receiving your equipment remove the protective container. Do a complete visual inspection, and if damage is noted, **photograph it for insurance claims** and contact your carrier at once, requesting inspection. Also contact Baileigh Industrial Holdings LLC and inform them of the unexpected occurrence. Temporarily suspend installation.

Take necessary precautions while loading / unloading or moving the machine to avoid any injuries.

Your machine is designed and manufactured to work smoothly and efficiently. Following proper maintenance instructions will help ensure this. Try and use original spare parts, whenever possible, and most importantly; **DO NOT** overload the machine or make any modifications.



Note: This symbol refers to useful information throughout the manual.



IMPORTANT

PLEASE READ THIS OPERATORS MANUAL CAREFULLY

It contains important safety information, instructions, and necessary operating procedures. The continual observance of these procedures will help increase your production and extend the life of the equipment.

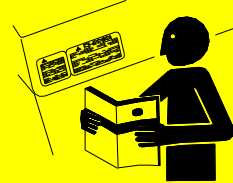

SAFETY INSTRUCTIONS

LEARN TO RECOGNIZE SAFETY INFORMATION

This is the safety alert symbol. When you see this symbol on your machine or in this manual, **BE ALERT TO THE POTENTIAL FOR PERSONAL INJURY!**



Follow recommended precautions and safe operating practices.

UNDERSTAND SIGNAL WORDS

A signal word – **DANGER**, **WARNING**, or **CAUTION** – is used with the safety alert symbol. **NOTICE**, which is not related to personal injury, is used without a symbol.

DANGER: Indicates a hazardous situation which, if not avoided, will result in death or serious injury.

WARNING: Indicates a hazardous situation which, if not avoided, could result in death or serious injury.

CAUTION: Indicates a hazardous situation which, if not avoided, could result in minor or moderate injury.

NOTICE: Indicates a situation which, if not avoided, could result in property damage.

DANGER

WARNING

CAUTION

NOTICE



SAVE THESE INSTRUCTIONS.
Refer to them often and use them to instruct others.



PROTECT EYES

Wear safety glasses or suitable eye protection when working on or around machinery.

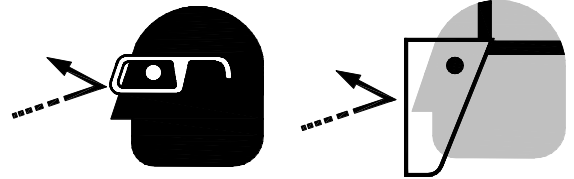

PROTECT AGAINST NOISE

Prolonged exposure to loud noise can cause impairment or loss of hearing. Wear suitable hearing protective devices such as earmuffs or earplugs to protect against objectionable or uncomfortable loud noises.

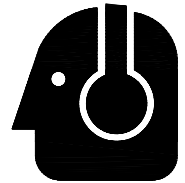

CALIFORNIA PROPOSITION 65

WARNING: Cancer and Reproductive Harm.
www.P65Warnings.ca.gov



BEWARE OF PINCH POINTS

Keep hands and fingers away from the rolls when the machine is in operation.

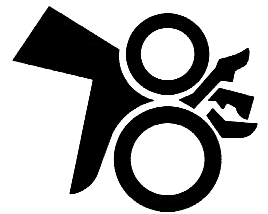

BEWARE OF PINCH POINTS AND CRUSH HAZARD

Keep hands and fingers from between the roller and die when bending materials to avoid possible injury.

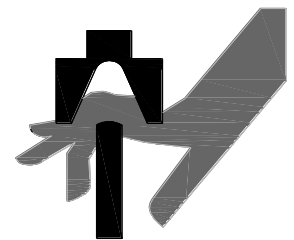

NEVER place your hands, fingers, or any part of your body in the die area of this machine.



SAFETY PRECAUTIONS



Metal working can be dangerous if safe and proper operating procedures are not followed. As with all machinery, there are certain hazards involved with the operation of the product. Using the machine with respect and caution will considerably lessen the possibility of personal injury. However, if normal safety precautions are overlooked or ignored, personal injury to the operator may result.

Safety equipment such as guards, hold-downs, safety glasses, dust masks and hearing protection can reduce your potential for injury. But even the best guard will not make up for poor judgment, carelessness or inattention. **Always use common sense** and exercise **caution** in the workshop. If a procedure feels dangerous, don't try it.

REMEMBER: Your personal safety is your responsibility.



WARNING: FAILURE TO FOLLOW THESE RULES MAY RESULT IN SERIOUS PERSONAL INJURY

Dear Valued Customer:

- All Baileigh machines should be used only for their intended use.
- Baileigh does not recommend or endorse making any modifications or alterations to a Baileigh machine. Modifications or alterations to a machine may pose a substantial risk of injury to the operator or others and may do substantial damage to the machine.
- Any modifications or alterations to a Baileigh machine will invalidate the machine's warranty.

PLEASE ENJOY YOUR BAILEIGH MACHINE!PLEASE ENJOY IT SAFELY!

1. **FOR YOUR OWN SAFETY, READ INSTRUCTION MANUAL BEFORE OPERATING THE MACHINE.** Learn the machine's application and limitations as well as the specific hazards.
2. **Only trained and qualified personnel can operate this machine.**
3. **Make sure guards are in place and in proper working order before operating machinery.**
4. **Remove any adjusting tools.** Before operating the machine, make sure any adjusting tools have been removed.
5. **Keep work area clean.** Cluttered areas invite injuries.
6. **Overloading machine.** By overloading the machine, you may cause injury from flying parts. **DO NOT** exceed the specified machine capacities.
7. **Dressing material edges.** Always chamfer and deburr all sharp edges.



8. **Do not force tool.** Your machine will do a better and safer job if used as intended. **DO NOT** use inappropriate attachments in an attempt to exceed the machine's rated capacity.
9. **Use the right tool for the job. DO NOT** attempt to force a small tool or attachment to do the work of a large industrial tool. **DO NOT** use a tool for a purpose for which it was not intended.
10. **Dress appropriately. DO NOT** wear loose fitting clothing or jewelry as they can be caught in moving machine parts. Protective clothing and steel toe shoes are recommended when using machinery. Wear a restrictive hair covering to contain long hair.
11. **Use eye protection.** Always wear ISO approved protective eye wear when operating machinery. Wear a full-face shield if you are producing metal filings. Eye wear shall be impact resistant, protective safety glasses with side shields which comply with ANSI Z87.1 specification. Use of eye wear which does not comply with ANSI Z87.1 specification could result in severe injury from breakage of eye protection.
12. **Do not overreach.** Maintain proper footing and balance at all times. **DO NOT** reach over or across a running machine.
13. **Stay alert.** Watch what you are doing and use common sense. **DO NOT** operate any tool or machine when you are tired.
14. **Check for damaged parts.** Before using any tool or machine, carefully check any part that appears damaged. Check for alignment and binding of moving parts that may affect proper machine operation.
15. **Observe work area conditions. DO NOT** use machines or power tools in damp or wet locations. Do not expose to rain. Keep work area well lighted. **DO NOT** use electrically powered tools in the presence of flammable gases or liquids.
16. **Keep children away.** Children must never be allowed in the work area. **DO NOT** let them handle machines, tools, or extension cords.
17. Keep visitors a safe distance from the work area.
18. **Store idle equipment.** When not in use, tools must be stored in a dry location to inhibit rust. Always lock up tools and keep them out of reach of children.
19. **DO NOT operate machine if under the influence of alcohol or drugs.** Read warning labels on prescriptions. If there is any doubt, **DO NOT** operate the machine.
20. **Turn off** power before checking, cleaning, or replacing any parts.
21. Be sure **all** equipment is properly installed and grounded according to national, state, and local codes.
22. Keep **all** cords dry, free from grease and oil, and protected from sparks and hot metal.
23. Inspect power and control cables periodically. Replace if damaged or bare wires are exposed. **Bare wiring can kill!** **DO NOT** touch live electrical components or parts.
24. **DO NOT** bypass or defeat any safety interlock systems.



TECHNICAL SPECIFICATIONS

This bead roller is power driven and will form sheet metal up to 16 Gauge thickness mild steel (or equivalent). The Rotary machine is constructed of cast iron and steel ensuring minimum deflection of the work-piece during forming operations. Available die sets allow for the following operations to be performed: wiring, edging, ogee bead, single bead, and elbow edging.

Model	BR18E-24
Capacity	16ga.(1.52mm) mild steel
Throat Depth	24" (609mm)
Power	110VAC
Motor HP	1/8hp (.09kw)
Shipping Dimensions (L x W x H)	61.8" x 22.5" x 21.6" (1570 x 570 x 550mm)
Weight (Net/Gross)	172lbs. (78kg) / 227lbs. (103kg)
Based on a material tensile strength of *60000 PSI – mild steel	

Model	BE18E-36
Capacity	16ga.(1.52mm) mild steel
Throat Depth	36" (914mm)
Power	110VAC
Motor HP	1/8hp (.09kw)
Shipping Dimensions (L x W x H)	61.8" x 22.5" x 21.6" (1570 x 570 x 550mm)
Weight (Net/Gross)	172lbs. (78kg) / 227lbs. (103kg)
Based on a material tensile strength of *60000 PSI – mild steel	

TECHNICAL SUPPORT

Our technical support department can be reached at 920.684.4990 and asking for the support desk for purchased machines. Tech Support handles questions on machine setup, schematics, warranty issues, and individual parts needs: (other than die sets and blades).

For specific application needs or future machine purchases contact the Sales Department at: sales@baileigh.com, Phone: 920.684.4990, or Fax: 920.684.3944.



Note: *The photos and illustrations used in this manual are representative only and may not depict the actual color, labeling or accessories and may be intended to illustrate technique only.*



Note: *The specifications and dimensions presented here are subject to change without prior notice due to improvements of our products.*



UNPACKING AND CHECKING CONTENTS

Your Baileigh machine is shipped complete. Separate all parts from the packing material and check each item carefully. Make certain all items are accounted for before discarding any packing material.

⚠ WARNING: SUFFOCATION HAZARD! Immediately discard any plastic bags and packing materials to eliminate choking and suffocation hazards to children and animals.
If any parts are missing, **DO NOT** place the machine into service until the missing parts are obtained and installed correctly.

Cleaning

⚠ WARNING: DO NOT USE gasoline or other petroleum products to clean the machine. They have low flash points and can explode or cause fire.

⚠ CAUTION: When using cleaning solvents work in a well-ventilated area. Many cleaning solvents are toxic if inhaled.

Your machine may be shipped with a rustproof waxy coating and/or grease on the exposed unpainted metal surfaces. Fully and completely remove this protective coating using a degreaser or solvent cleaner. Moving items will need to be moved along their travel path to allow for cleaning the entire surface. For a more thorough cleaning, some parts will occasionally have to be removed. **DO NOT USE** acetone or brake cleaner as they may damage painted surfaces.

Follow manufacturer's label instructions when using any type of cleaning product. After cleaning, wipe unpainted metal surfaces with a light coating of quality oil or grease for protection.



Important: This waxy coating is **NOT** a lubricant and will cause the machine to stick and lose performance as the coating continues to dry.





INSTALLATION

IMPORTANT:

Consider the following when looking for a suitable location to place the machine:

- Overall weight of the machine.
- Weight of material being processed.
- Sizes of material to be processed through the machine.
- Space needed for auxiliary stands, worktables, or other machinery.
- Clearance from walls and other obstacles.
- Maintain an adequate working area around the machine for safety.
- Have the work area well illuminated with proper lighting.
- Keep the floor free of oil and make sure it is not slippery.
- Remove scrap and waste materials regularly, and make sure the work area is free from obstructing objects.
- If long lengths of material are to be fed into the machine, make sure that they will not extend into any aisles.
- **LEVELING:** The machine should be sited on a level, concrete floor. Provisions for securing it should be in position prior to placing the machine. The accuracy of any machine depends on the precise placement of it to the mounting surface.
- **FLOOR:** This machine distributes a large amount of weight over a small area. Make certain that the floor is capable of supporting the weight of the machine, work stock, and the operator. The floor should also be a level surface. If the unit wobbles or rocks once in place, be sure to eliminate by using shims.
- **WORKING CLEARANCES:** Take into consideration the size of the material to be processed. Make sure that you allow enough space for you to operate the machine freely.
- **POWER SUPPLY PLACEMENT:** The power supply should be located close enough to the machine so that the power cord is not in an area where it would cause a tripping hazard. Be sure to observe all electrical codes if installing new circuits and/or outlets.

Anchoring the Machine

- Once positioned, anchor the machine to the floor, as shown in the diagram. Use bolts and expansion plugs or sunken tie rods that connect through and are sized for the holes in the base of the stand.
- This machine requires a solid floor such as concrete at a minimum of 4" (102mm) thick. 6" (153mm) minimum is preferred.

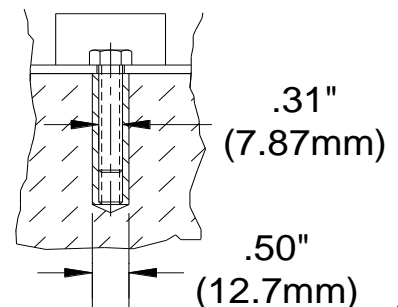



ASSEMBLY

⚠ WARNING: For your own safety, **DO NOT** connect the machine to the power source until the machine is completely assembled and you read and understand the entire instruction manual.



Note: While one person using proper lifting techniques can assemble and lift the roller as needed, it is advisable to have and use an assistant.

1. Unpack the components from the shipping crate and place the stand in an open and solid location to allow for the assembly to be completed.
2. Place the bead roller head onto the stand into the mounting channel with the roll shafts over the tapered side of the base.
3. Gently press down on the roller shafts to rock the back of the roll head upward to align the bolt holes.





4. Insert a M12 x 70 hex head bolt (A) with M12 washer (B) into the channel hole placing the spacer washer (C) between the channel and the head body.
5. Lift up on the roll head to insert M12 x 70 hex head bolt (A), M12 washer (B) and spacer (C) into the front mounting hole.
6. ON the opposite side, install a spacer washer (C) between the channel and the head and then install the M12 washer (B) and M12 nut (D).
7. Tighten securely.

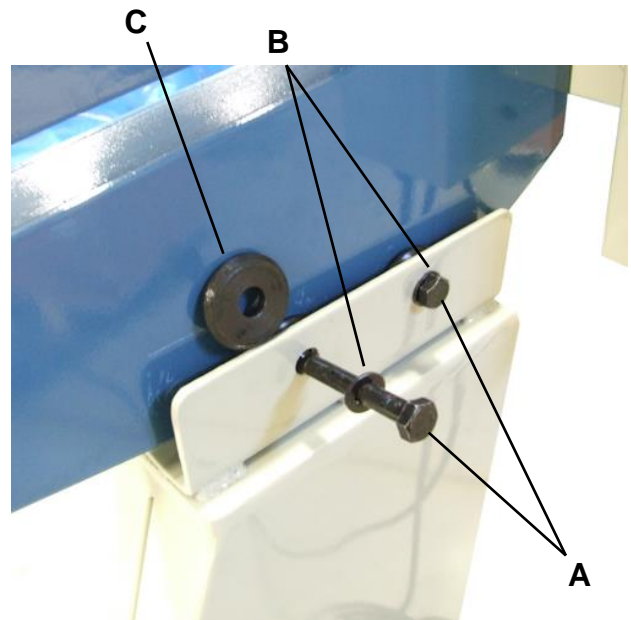
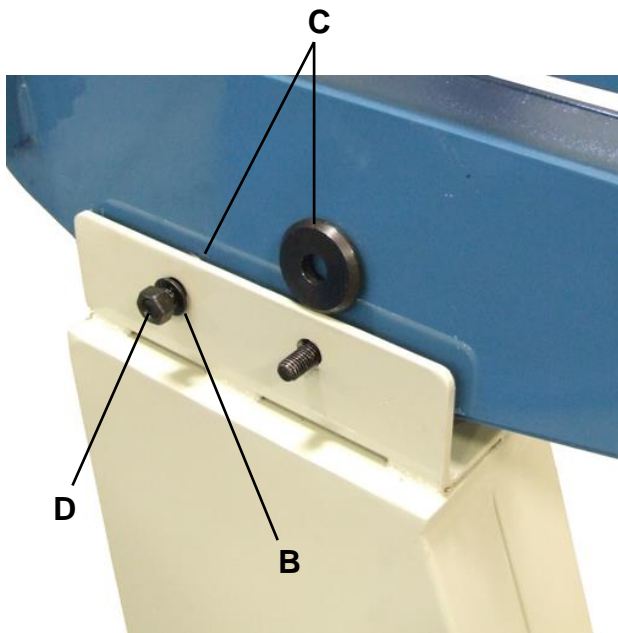

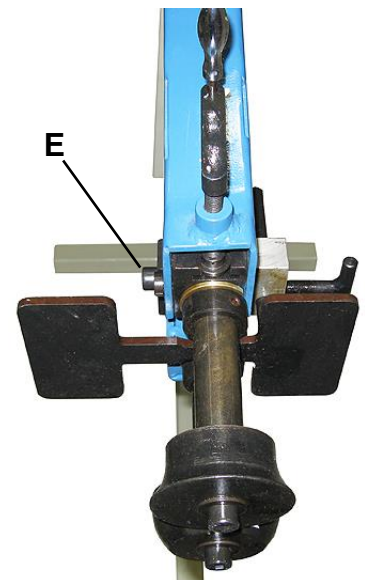

8. Remove the M10 x 40 socket head bolt (E) and clamping block from the material back stop and insert the back stop into the throat of the roller head.
9. Position the material stop where desired and snug the M10 x 40 socket head bolt (E) to hold the stop in position. Fine tune the material stop by loosening the T-handle bolt, positioning the material stop, and tightening the T-handle bolt.
10. Plug into the 110V volt power and test the operation.





ELECTRICAL

 **CAUTION:** HAVE ELECTRICAL UTILITIES CONNECTED TO MACHINE BY A CERTIFIED ELECTRICIAN!
Check if the available power supply is the same as listed on the machine nameplate.

 **WARNING:** Make sure the grounding wire (green) is properly connected to avoid electric shock. DO NOT switch the position of the green grounding wire if any electrical plug wires are switched during hookup.

Power Specifications

Your machine is wired for 110 volts, 60hz alternating current. Before connecting the machine to the power source, make sure the power source is OFF.

Before switching on the power, you must check the voltage and frequency of the power to see if they meet with the requirement, the allowed range for the voltage is $\pm 5\%$, and for the frequency is $\pm 1\%$.

Considerations

- Observe local electrical codes when connecting the machine.
- The circuit should be protected with a time delay fuse or circuit breaker with an amperage rating slightly higher than the full load current of machine.
- A separate electrical circuit should be used for your machines. Before connecting the motor to the power line, make sure the switch is in the "OFF" position and be sure that the electric current is of the same characteristics as indicated on the machine.
- All line connections should make good contact. Running on low voltage will damage the motor.
- In the event of a malfunction or breakdown, grounding provides a path of least resistance for electric current to reduce the risk of electric shock. This machine is equipped with an electric cord having an equipment-grounding conductor and a grounding plug. The plug must be plugged into a matching outlet that is properly installed and grounded in accordance with all local codes and ordinances.

 **WARNING:** In all cases, make certain the receptacle in question is properly grounded. If you are not sure, have a qualified electrician check the receptacle.



- Improper connection of the equipment-grounding conductor can result in risk of electric shock. The conductor with insulation having an outer surface that is green with or without yellow stripes is the equipment-grounding conductor. If repair or replacement of the electric cord or plug is necessary, do not connect the equipment-grounding conductor to a live terminal.
- Check with qualified electrician or service personnel if the grounding instructions are not completely understood, or if in doubt as to whether the machine is properly grounded.
- Repair or replace damaged or worn cord immediately.

Extension Cord Safety

Extension cord should be in good condition and meet the minimum wire gauge requirements listed below:

AMP RATING	LENGTH		
	25ft	50ft	100ft
1-12	16	16	14
13-16	14	12	12
17-20	12	12	10
21-30	10	10	No
WIRE GAUGE			

An undersized cord decreases line voltage, causing loss of power and overheating. All cords should use a ground wire and plug pin. Replace any damaged cords immediately.

Power cord connection:

1. Turn the main disconnect switch on the control panel to the OFF position.
2. Unwrap the power cord and route the cord away from the machine toward the power supply.
 - a. Route the power cord so that it will NOT become entangled in the machine in any way.
 - b. Route the cord to the power supply in a way that does NOT create a trip hazard.
3. Connect the power cord to the power supply and check that the power cord has not been damaged during installation.
4. When the machine is clear of any obstruction. The main power switch may be turn ON to test the operation. Turn the switch OFF when the machine is not in operation.



GENERAL BEAD ROLLING

Bead rolling is both functional and artistic. The functional portion of this operation will add strength and rigidity to sheet material. The artistic portion will add aesthetic appeal to the design. Both operations require practice and experience to perfect.

When safety and machine capacity are taken into account, the remaining is open to the imagination and creativity of the metal worker.

- Never exceed the machines capacity. Keeping in mind items like seams and hems increase the material thickness which may exceed the machines capacity.
- Never handle material larger than you are able to comfortably control. Keep in mind that when the material is being rolled it the forces of the rolls will cause the material to move and twist. Use additional equipment such as back gauges, tables, and additional persons to support and secure materials as needed.
- Take several passes. Most beads will require several passes to obtain the desired depth. Planning and practice will assist with this. Practice on similar material to become familiar with how the material will react and to predict the number of passes and the depth of each pass.

ROLLER INSTALLATION AND REMOVAL



Note: Spoiler rolls (included with machine) shown. All other roll design installation is similar.

1. Use the handwheel to open the roll gap enough for the rolls to clear each other.
2. Remove the retaining bolt and washer.
3. Remove the spacer(s) and rolls.
4. Select and install the die set required for the desired bead type.
5. Place spacers, roll dies and retaining bolts onto the driving and driven shafts.



Note: Conventional roll installation and spacer placement is shown above.

- Either roller can be top or bottom depending on your application.





- *Spacers may be placed in front of, in back of, or on either side of the roll die.*
 - *The roll dies may be spaced exactly the same or in any variation of positions based upon the spacer thickness combinations.*
6. Verify that the spacer and roll combination is thick enough to extend just longer than the shaft. This will allow for the bolt and washer to secure the roll.
 7. Tighten the retaining bolts so that the washer secures the spacer and roll preventing the roll from spinning on the shaft.





OPERATION

⚠ CAUTION: Always wear proper eye protection with side shields, safety footwear, and leather gloves to protect from burrs and sharp edges.

⚠ CAUTION: Keep hands and fingers clear of the rolling dies. Be aware of how the material moves as it is being formed. Normally the operator should stand in front of the bead roller to avoid getting hit with the material as it is being formed. When handling large heavy materials make sure they are properly supported.

1. Unplug the power cord whenever changing dies.
2. Select and install the die set required for the desired bead type.
3. Use the handwheel to open the gap between the roll dies large enough to insert the material. Do not start with the rolls completely closed as you may find that the rolls are too close together and find it difficult to feed the material.
4. Set the depth gauge as desired to assist in positioning the material between the dies. This also assists in repeatability.
5. Place the Forward/Reverse switch in the desired position based upon direction of feed. Forward will feed material from right to left. Reverse will feed material from left to right.
6. When the material is positioned as desired, closed the gap between the rolls to start to impress the rolls into the material. This step may require some experimentation to get the proper depth so it is recommended that you use a scrap piece of the same material you want to bead roll.



Note: Most beading operations will need to be done in several steps, increasing the depth on each pass. Trying to bead too deep will flex the machine, so take your time with multiple passes.



7. Lightly step down on the foot pedal while feeding the work-piece through the die set. Check the work-piece. It may be necessary to fine tune the adjustment to the depth of the bead to reach the desired bead depth.
8. When the material has been fed through the rolls for one pass, release the foot pedal and then, either remove the material if the bead is complete, or toggle the switch to the opposite directions and feed the material back in the opposite direction increasing the pressure on the rolls.
9. This may be repeated until the desired bead is achieved.



MATERIAL SELECTION

⚠ CAUTION: It must be determined by the customer that materials being processed through the machine are NOT potentially hazardous to operator or personnel working nearby.

When selecting materials keep these instructions in mind:

- Material must be clean and dry. (without oil)
- Material should have a smooth surface so it processes easily.
- Dimensional properties of material must be consistent and not exceed the machine capacity values.
- Chemical structure of material must be consistent.
- Buy certificated steel from the same vendor when possible.



UNDERSTANDING SPRINGBACK

Springback, also known as elastic recovery, is the result of the metal wanting to return to its original shape after undergoing compression and stretch. After the bending leaf is removed from the metal and the load is released, the piece part relaxes, forcing the bent portion of the metal to return slightly to its original shape. The key to obtaining the correct bend angle is to over bend the metal a little and allow it to spring back to the desired angle. All metals exhibit a certain amount of spring back.

LUBRICATION AND MAINTENANCE



WARNING: Make sure the electrical disconnect is OFF before working on the machine.

Maintenance should be performed on a regular basis by qualified personnel.

Always follow proper safety precautions when working on or around any machinery.

- Check daily for any unsafe conditions and fix immediately.
- Check that all nuts and bolts are properly tightened.
- On a weekly basis clean the machine and the area around it.
- Lubricate threaded components and sliding devices.
- Apply rust inhibitive lubricant to all non-painted surfaces.
- The adjusting block should be greased.
- Oil the driving shaft bronze bushings monthly with a drop or two of 30W or 40W oil.



Note: *Proper maintenance can increase the life expectancy of your machine.*

PARTS DIAGRAM A

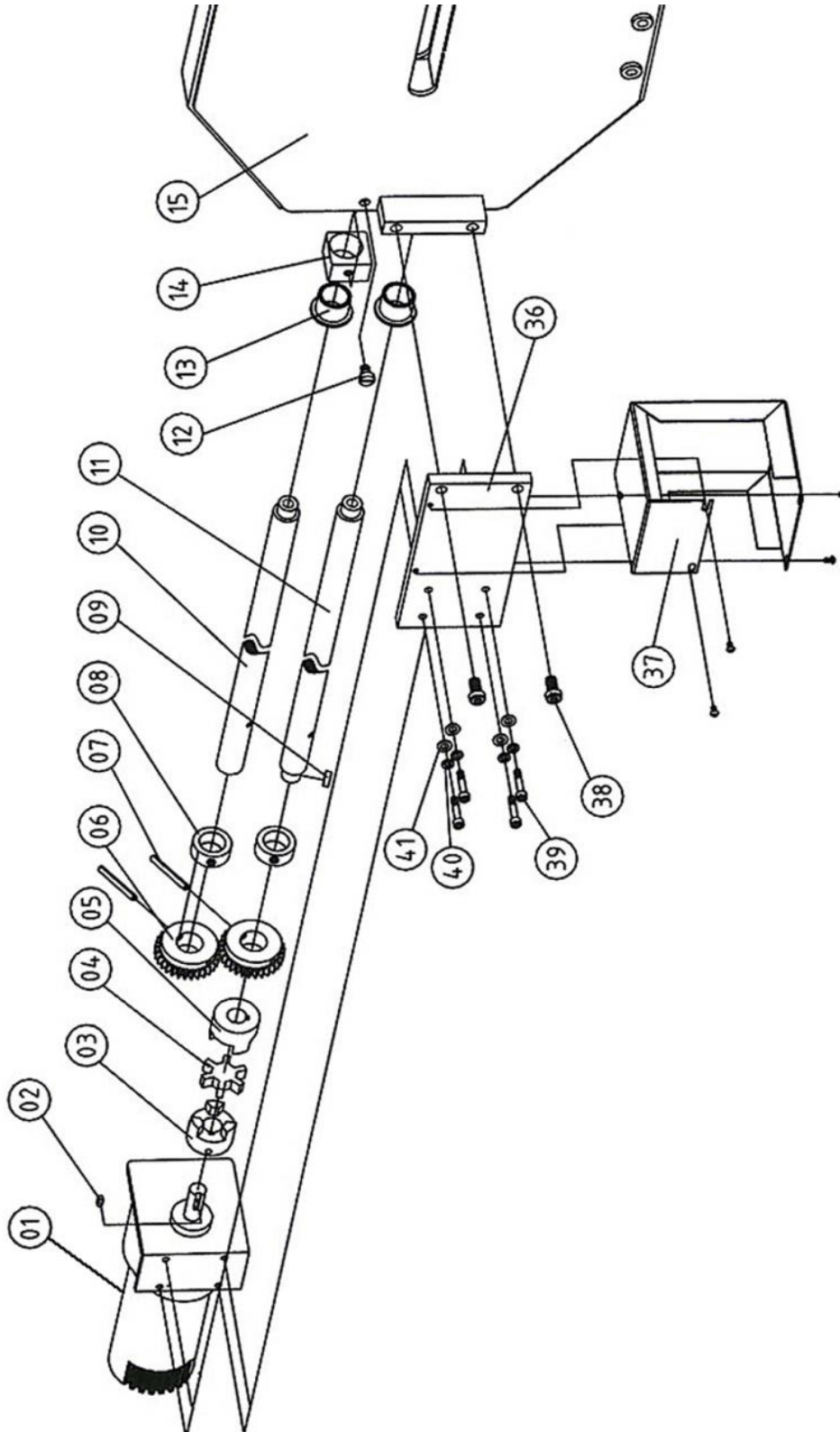



PARTS DIAGRAM B

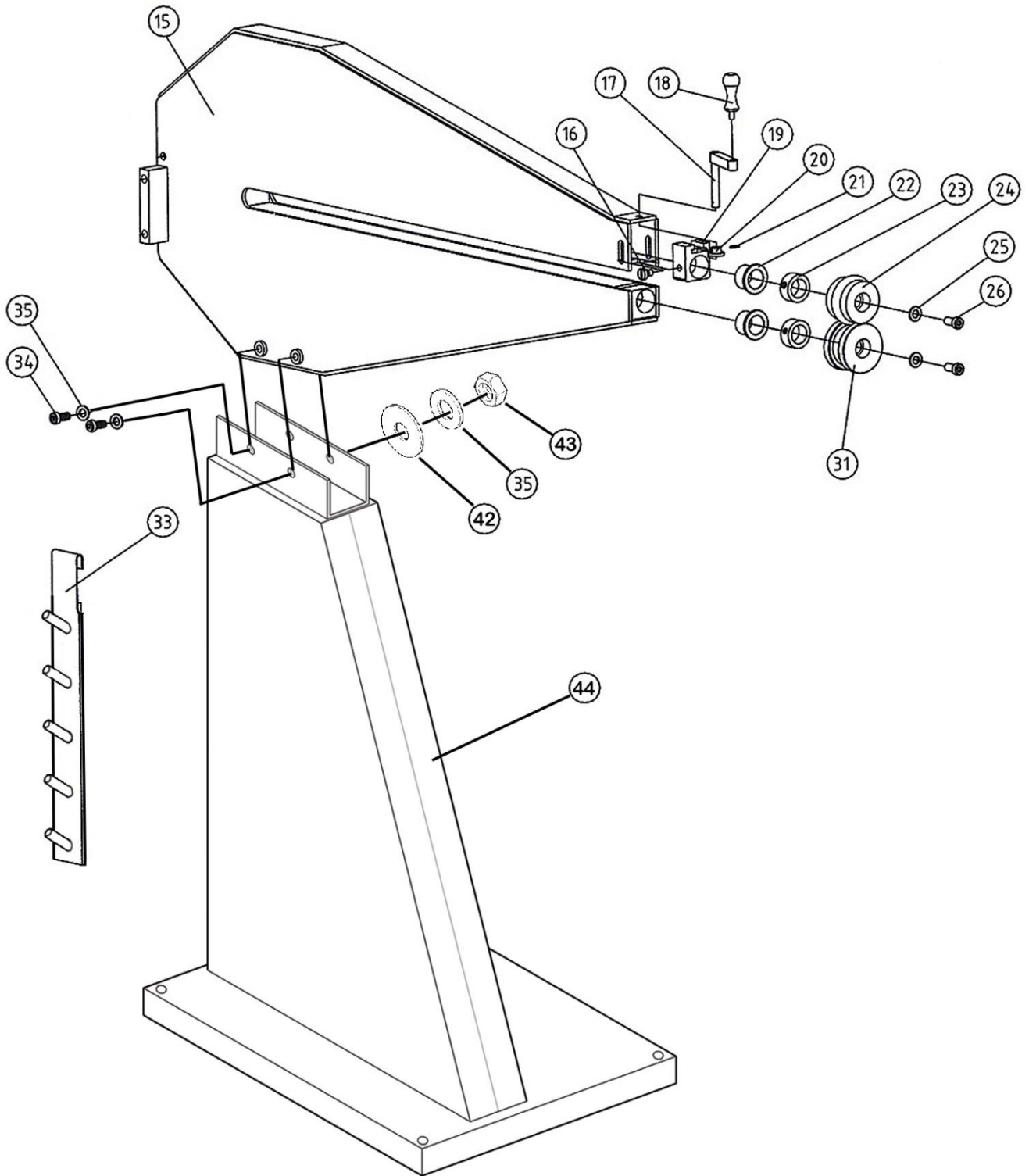



Parts Identification List

Item	Part No.	Description	Qty.
1	BR18E-Motor and Gearbox	Motor and Gearbox	1
	BR18E-Motor-BC	DC Motor Brush Cap (Black Plastic) 1pc	
	BR18E-Motor Brush	DC Motor Brush	
	BR18E-Motor Brush Holder	DC Motor Brush Holder with Cap	
2	BR18E-2	Key	1
3	BR18E-3	Coupler Hub	1
4	BR18E-4	Coupler Cushioning Insert	1
5	BR18E-5	Coupler Hub	1
	BR18E24-3-5	Coupler Hub and Cushion Assembly	
6	BR18E-6	Gear	2
7	BR18E-7	Spring Roll Pin	2
8	BR18E36-8	Set Collar 26 x 38 x 16mm (w/Set Screw M8-1.25 x 6)	2
9	BR18E-9	Key	1
10	BR18E24-EX. Top Shaft	Upper Shaft 24"	1
11	BR18E24-EX. Bottom Shaft	Lower Shaft 24"	1
10	BR18E36-EX. Top Shaft	Upper Shaft 36"	1
11	BR18E36-EX. Bottom Shaft	Lower Shaft 36"	1
12	BR18E-12	Bolt	1
13	BR18E-13	Bronze Oil-lite Bearing, Flanged (Copper Collar A) 26 x 32 x 25.5mm, 41 x 3mm	3
14	BR18E-14	Upper Shaft Back Block	1
15	BR18E24-15	Roller Head Frame 24"	1
	BR18E36-15	Roller Head Frame 36"	
16	BR18E-16	Bolt	1
17	BR18E-17	Handle Mount	1
18	BR18E-18	Handle	1
19	BR18E-19	Upper Shaft Front Block	1
20	BR18E-20	Nut	1
21	BR18E-21	Spring Roll Pin 3 x 14mm	1



Item	Part No.	Description	Qty.
22	BR18E-22	Bronze Oil-lite Bearing, Flanged (Copper Collar B) 26 x 32 x 25.5mm, 41 x 3mm	3
23	BR18E-23	Set Collar	2
24	BR18E-24	Upper Die	1
25	BR18E-25	Washer	2
26	BR18E-26	Socket Head Cap Screw	2
31	BR18E-31	Lower Die	1
33	BR18E-33	Roll Hold	1
34	BR18E-34	Hex Head Cap Screw	2
35	BR18E-35	Washer	4
36	BR18E-36	Motor Mount Plate	1
37	BR18E-37	Switch Box Cover	1
38	BR18E-38	Socket Head Cap Screw	2
39	BR18E-39	Socket Head Cap Screw	4
40	BR18E-40	Spring Washer	4
41	BR18E-41	Washer	4
42	BR18E-42	Spacer Washer	4
43	BR18E-43	Nut	4
44	BR18E-44	Stand Weldment	1
	BR18E-Depth Stop	Adjustable Depth Stop	
	BR18E-Foot Pedal	Complete Foot Pedal with Cable	
	BR18E-Foot Pedal Gear Set	Gear Set in the Foot Pedal	
	BR18E-Table HWR	Hardware bag (9pcs handles and shims) for table attachment	
	BR18E-Work Table	Fully Adjustable Work Table, includes hardware bag	



ELECTRICAL SCHEMATIC

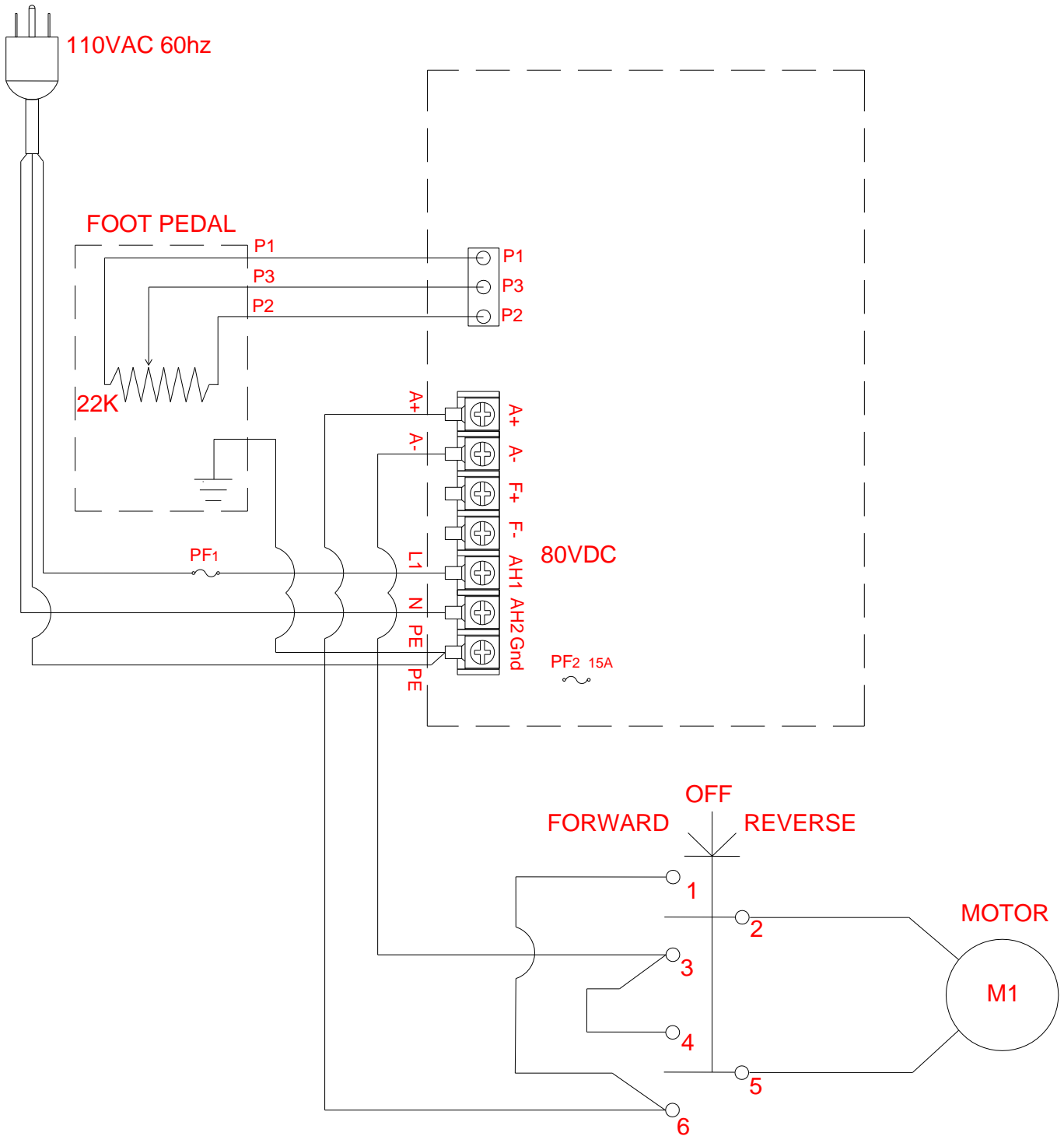



Electrical Components

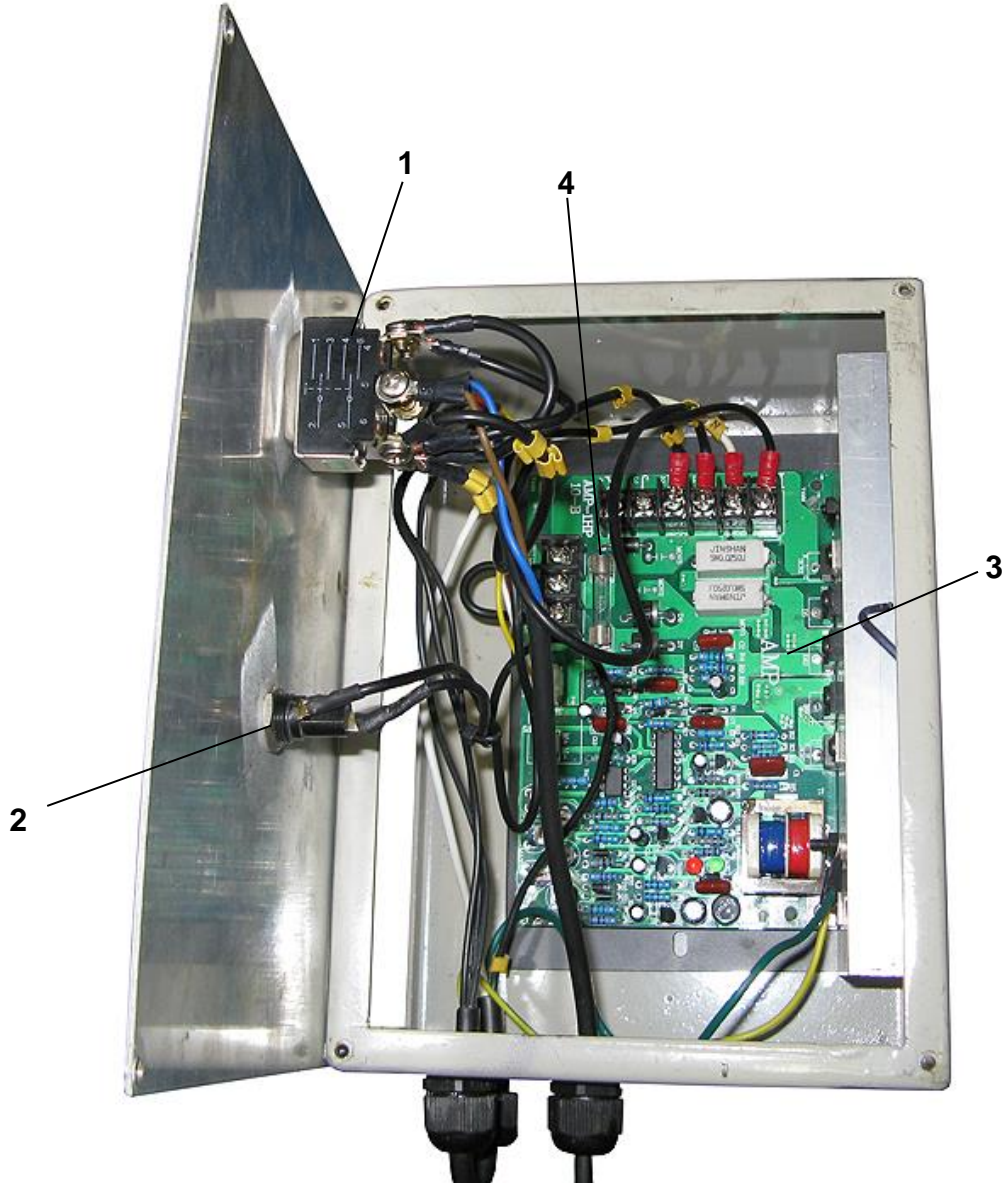

Item	Item	Description	Specification
1	BR18E-Switch	Selector Switch	HY29D
2	BR18E-Fuse Holder	Main Power Fuse Holder	F15A 250V
3	BR18E-Control Board	Motor Controller Board	AMP-1hp, 10-B
4	4	Controller Fuse	F15AL 250V
	BR18E-Foot Pedal Pot	Potentiometer (Foot Pedal)	22K Ω 2W
	BR18E-Motor and Gearbox	Motor	1/8 hp (.09 kw) 90 VDC 1.8A



NOTES

BAILEIGH INDUSTRIAL HOLDINGS LLC
1625 DUFEK DRIVE MANITOWOC, WI 54220
PHONE: 920. 684. 4990 FAX: 920. 684. 3944
www.baileigh.com